

RADIUS MEASUREMENT OF CYLINDRICAL SURFACES BASED ON ANALYZING THE INTERFERENCE PATTERN OBTAINED BY SCANNING THE SURFACE WITH FOCUSED LASER BEAM

Ryszard Jabłoński, Jerzy Mąkowski

Abstract:

A focused laser beam is incident on the edge of cylindrical object. The reflected edge wave is interfering with geometrical wave forming fringe pattern containing the information about the surface local curvature. This can be determined by analyzing the detector output signal.

Keywords: radius of curvature, laser diffraction, interference pattern.

1. Introduction

In laser-scanning measurement of cylindrical objects extremely complex interfering signals occur. They are due to superimposition of reflected, geometrical and scattered light. The proportions between these components vary in time, and also the total intensity distribution changes. The considerations applying Fraunhofer theory are static and fragmentary, and it may be concluded that the existing solutions for diffraction of 3D bodies do not fit to engineering applications.

A rigorous diffraction theory is based on Maxwell's equation and the boundary conditions are associated with the obstacle [1]. The boundary conditions are used to calculate a field scattered by the obstacle. The origins of this scattered field are currents introduced in the obstacle by the incident field. The scattered field is allowed to interfere with the unobstructed field to produce resultant interference pattern.

Within the Kirchhoff theory of diffraction there are two possible ways of interpretation the diffraction phenomena. The first one, based on so called "edge wave", which refers to T. Young idea was later extended by A. Rubinowicz and the second Fresnel diffraction model, is based on the "zones concept". T. Young interpreted the diffraction phenomena as a result of interference of the geometrical wave propagating in free space with "the edge wave" A. Rubinowicz [2]. Theoretically it proved the possibility of division the Kirchhoff diffraction field into two components. One of them has the character of incident wave and the second represents the wave created by interaction between primary field and the edge of object, and this interaction is of reflection type. These mathematical considerations are commonly accepted in the scientific world, but were never proved experimentally.

In the paper the geometrical wave is the undisturbed part of incident wave. The edge wave is the wave generated by the edge of an object (it is the wave reflected by the fragment of cylindrical surface considered to be as the edge of the object). These two waves interfere and

form fringe pattern containing the information about the local curvature.

Having the above in view, the close analysis of detector signal was carried out. The obtained intensity characteristics allow determining the curvature of the surface.

2. Measuring set-up

The outlook of the experimental set-up is presented in Fig.1. (it was described in [3]). The auxiliary components like: system assuring parallel laser travel, vibration protection set-up, dark chamber, detector electronics, computer, etc, are not shown in the figure.

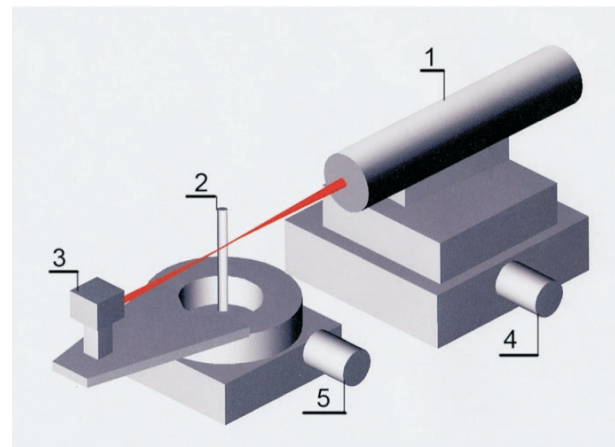

Fig. 1. Experimental set-up.

The unit (1) contains laser, beam forming optics (beam expander with spatial filter) and scan lens. The transformed laser beam is directed to the object (2) and the generated intensity distribution pattern is measured by detector unit (3) and then processed by computer. Computer controls the step motors (4) and (5) by means of interface in/out LC-012-1612. The motor (4) scans the laser unit and motor (5) scans the detector. Laser and detector are supplied by separate power sources.

The experiment was limited to the edge effect – it means only to the area located nearby the shadow border line (where the strong diffraction effect is expected).

In order to avoid the inaccuracies caused by the instabilities of angular deflection, the entire laser head is scanned parallel to beam axes (in 2.5m steps). The detector unit (fixed to the rotary table, coaxially with object axis) is composed of photodiode, aperture 0.3 mm and electronic circuit. It was calibrated with the power meter (LaserMate-Q, Coherent) and obtained signal (in V) is proportional to the measured light intensity.

3. Position of object edge in relation to the laser beam waist.

The determination of measuring area (location of measured object) is essential in all measuring instruments. In reference to the notations used in Fig. 2: the areas A and B represent two theoretical halves of laser beam. C is the shadow area and in D area the interference fringes appear.

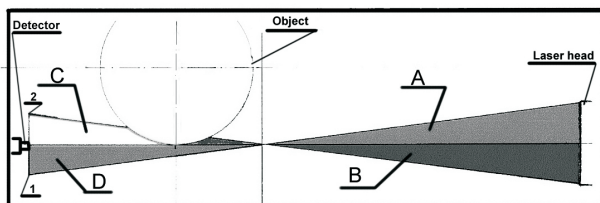

Fig. 2. Geometry of measuring area.

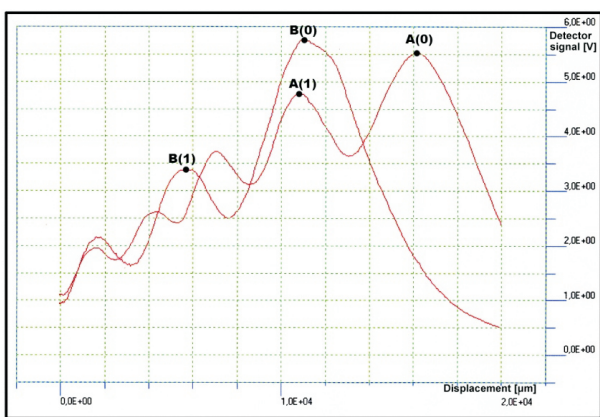

Fig. 3. An exemplary detector signal recorded by scanning the detector from point 1 to point 2.

In the designed system the beam waist is $2w_0 = 60 \mu\text{m}$ and its position in reference to the scanning lens is 65 mm. In experiments ϕ 0.9, 2, 2.5, 3, 4 mm cylinders were used, placed perpendicularly to the laser beam axes in the distance 57-85 mm from the laser head (scanning lens). The measurements were taken in 1mm step starting with 57 mm distance and the measuring quantity was the visibility of interference fringes. In each position the laser beam was screened by the edge of an object and the fragment of resulting interference pattern was recorded by scanning the detector from point 1 to point 2 (see notations in Fig. 2). The results were discussed in [4]. Depending on the position of an object the interference pattern changes significantly. Fig. 3 shows the exemplary plots of measurement data recorded by scanning the detector from point 1 to point 2. The course with points A(n) (reference course) represents the measurement data taken for such position of laser beam where the beam axes is tangent to the object surface. The course with points B(n) - optimum course, presents the data taken for beam axes being parallel displaced of about 1/3 of a beam size from the previous position. That choice is justified by the following reasoning:

with the transverse parallel displacement of laser beam the difference B1-A0 is increasing (what is considered as advantage), but the further displacement results are in gradual decreasing (and even disappearing) of the 3rd-order maximum (what is obvious disadvantage); the opti-

imum displacement was defined for 1/3 of beam diameter (it corresponds to 50 m for 75 mm distance from the laser head).

Fig. 3. presents the exemplary detector signal recorded by scanning the detector from point 1 to point 2.

We named the course with points A(n) as "a maximum of the first order interference fringe". This course is determined by scanning the edge of an object with laser beam in small steps. Out of the obtained plot of courses (Fig. 4) it is easy to select the one with maximum amplitude. This procedure was described in details in [5].

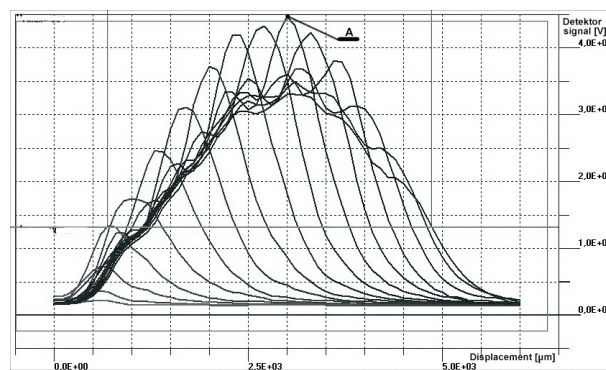

Fig. 4. Detector output signal obtained by scanning the edge of an object with laser beam. "The maximum of the first order interference fringe" is indicated as A.

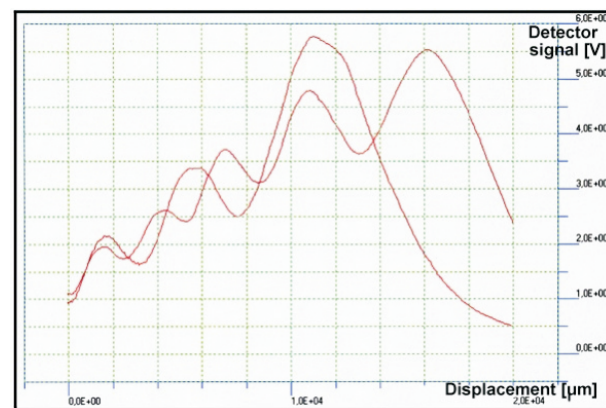

Fig. 5. The courses A(n) and B(n) for cylindrical object of radius 0.45 mm.

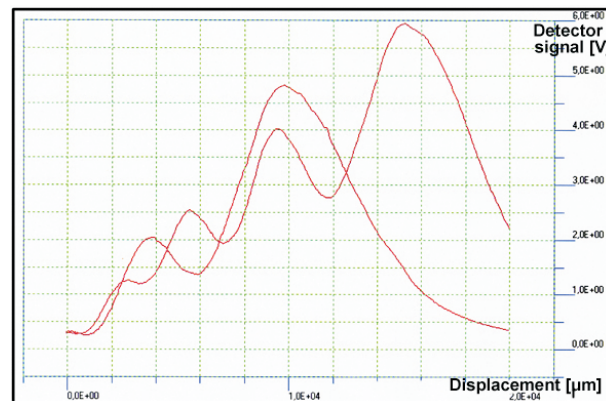

Fig 6. The courses A(n) and B(n) for cylindrical object of radius 2.0 mm.

At the distances below 65 mm the diffraction effects are visible on the left side of the graphs. The most

uncertain signal was detected at the positions close to the beam waist (it did not show any interference). When the distance 65 mm was exceeded the stronger and more distinct pattern appeared. The graph for 75 mm distance contains most information. There are clearly visible 6 interference fringes and also visibility of fringes is high.

Taking this object position as optimum, the series of measurement were performed with cylindrical objects of radius 0.45, 1.0, 1.25, 1.5 and 2.0 mm. The two exemplary results, for radius 0.45 mm and 2.0 mm, are shown in Figs. 5 and 6.

Table 1 shows xy coordinates of points A(0), B(0), A(1), B(1). We analyzed the results trying to define the peculiarities related to curvature (such as: number of fringes, fringes gradient, attenuation coefficient) and finally we selected the parameter called "interference signal gain". This parameter is given by relationship:

$$S_i = Y(0_A) - Y(1_B)$$

where:

$Y(0_A)$ – is the amplitude of detector signal level corresponding to the maximum of the first interference fringe in basic course.

$Y(1_B)$ – is the amplitude of detector signal corresponding to the maximum of the first interference fringe in optimum course.

The performed experiments prove the possibility of noncontact radius measurement of cylindrical objects with the use of interferometric phenomena.

The significant increase of interference signal, parameterized by S_i , enables to measure the radius (curvature) with the resolution 10 μm .

The interference maximum appears at the maximum of reference beam what enables the accurate determination of an edge of an object.

4. Simulation

Due to the very compound form of the above interference/diffraction phenomena, we decided to explain these effects by simulation.

In simulation we took the following assumptions:

- The investigated objects are the cylinders up to 5 mm diameter.

- The phenomenon can be analyzed with different wavelengths.
- The incident wave has plane wave front of unlimited widths.
- The cylinder surface was treated as unlimited set of light-reflecting sharp edges.
- Each elementary ray reflects from consecutive sharp edge.
- The reflected ray interferes with geometrical ray, Fig.7 (this is exactly the case discussed by Rubinowicz [2]).
- The results are presented graphically.
- Phase shift between geometrical wave and reflected wave was assumed only on the basis of path difference of these waves. The phase shift due to the reflection was not taken into account.

The obtained simulation results are presented in Fig. 8 and can be summarized as follows:

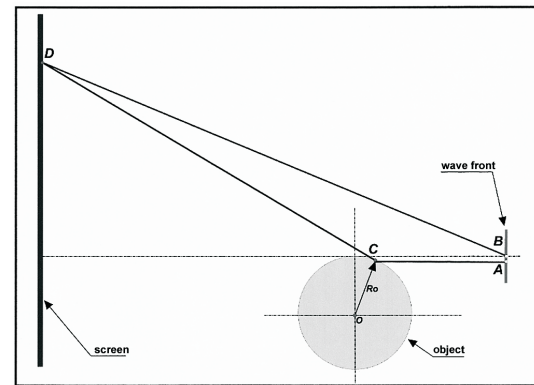

Fig. 7. Geometry of simulation experiment.

- The envelope of obtained signal (low frequency) is in good agreement with experimental results.
- Each cycle in high frequency signal corresponds to one wavelength path difference of interfering waves. This path difference is bigger for larger diameter of object.
- The presented results expand the Rubinowicz's considerations on the origin of edge wave [2].

Table 1. xy coordinates of points A(0), B(0), A(1), B(1) and parameter S_i .

Radius	Course	X(0)	Y(0)	X(1)	Y(1)	$X(0_A)-X(1_B)$	$Y(0_A)-Y(1_B)$
0,45	A	16100	5,53	10850	4,79	10250	2,16
	B	11050	5,77	5850	3,38		
1,0	A	14650	5,59	9150	4,77	11350	2,45
	B	9400	5,78	3300	3,14		
1,25	A	16250	5,69	10650	4,74	11600	2,69
	B	10750	5,62	4650	3,00		
1,5	A	17100	5,84	10500	4,48	11550	2,80
	B	11650	5,28	5550	3,04		
2,0	A	15200	5,94	9,450	4,02	11450	3,90
	B	9800	4,82	3750	2,04		

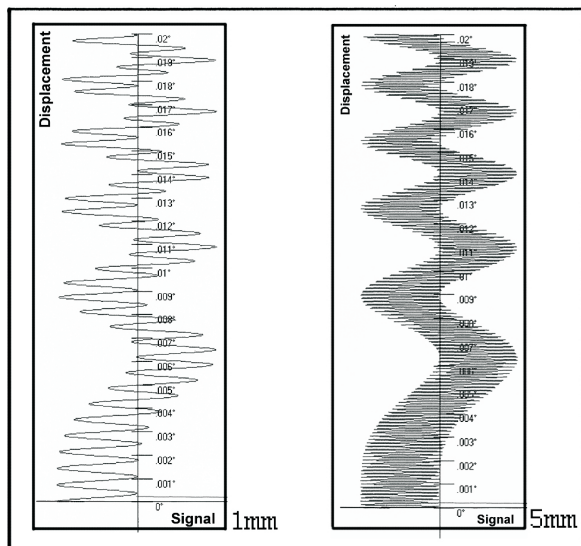

Fig. 8. Low and high frequency signal for cylinders of radius 0.5 mm and 2.5 mm.

5. Conclusion

1. Diffraction angle on the edge depends on the local radius.
2. The radius of an edge can be determined on base of analyzing the interference pattern.
3. The phase shift of the edge wave in relation to the geometrical wave has two components: optical path difference and phase shift on reflection.
4. The developed system enables the measurement of phase shift on reflection for incident angle close to 90 deg.

AUTHORS

Ryszard Jabłonski*, **Jerzy Makowski** – Faculty of Mechatronics, Warsaw University of Technology, Św. A. Boboli Str. 8, 02-525 Warsaw, Poland. E-mail: yabu@mchtr.pw.edu.pl

* Corresponding author

References

- [1] Born M., Wolf E., *Principles of optics*, Pergamon Press, Oxford, 1980.
- [2] Rubinowicz A., *Die Beugungswelle in der Kirchhof-fschen Theorie der Beugung*, Springer Verlag & PWN, Warsaw 1966. (in German)
- [3] Jablonski R., Makowski J., "New approach to fringe pattern analysis obtained by scanning polished metal cylinders with Gaussian beam" *Key Engineering Materials, Measurement Technology and Intelligent Instruments VIII*, Trans Tech Publications 2008, Zurich, pp. 267-270.
- [4] Jablonski R., Makowski J., "Metrological aspects of laser scanning system for measurement of cylindrical objects", *Mechatronics*, 2009, Springer Verlag (in press).
- [5] Jablonski R., J. Makowski J., "Comparison of fringe pattern obtained by scanning polished metal cylinders and sharp-edged objects with laser beam". In: *Proc. Int. Conf. ASPE/ICPE*, 19th-24th Oct. 2008, Portland Oregon USA, pp. 352-256.